

LVDT

Inductive Position Transducer



SM-F14 Series

Key-Features:

- Stainless steel housing
- Measurement ranges 2...10 mm
- Linearity up to $\pm 0,10$ % of full scale
- Protection class IP67 or IP68
- Sensor working temperature up to 200 °C
- Operating pressure 150 bar
- high EMC grade

Content:

INTRODUCTION

LVDTs (Linear Variable Differential Transformers) are inductive sensors excellent for use in harsh industrial environments, e.g. high temperature and pressure ranges, as well as high accelerations and measuring cycles.

The F14 series offers ultimate reliability and precision in a small size, and is designed for industrial and lab use. The position transducer is a pressurized hydraulic model up to 150 bar for installation directly in hydraulic and pneumatic cylinders. The sensors can also be used under water because of their high protection class and stainless steel housing.

IMCA and KAB electronics (explanation see page 5) have a built-in cable breakage monitoring and are entirely galvanically isolated. The signal output is optimized for interference compatibility with very low residual noise - the guarantee for ultimate resolution and measuring accuracy.

TECHNICAL DATA

Sensor			
Measurement range FS [mm]	0...2	0...5	0...10
Linearity [% of FS]	0.30 % (0.20 % optional, 0.10 % for selected models)		
Types	spring loaded (up to range 0...5 mm), free core, push rod guided/ unguided		
Protection class cable/ connector side	IP67, optional IP68 (connector output radial LEMO IP50)		
Protection class flange side	IP68/ 150bar		
Vibration stability DIN IEC68T2-6	10 G		
Shock stability DIN IEC68T2-27	200 G/ 2 ms		
Supply voltage/ frequency	3 V _{eff} / 3 kHz		
Supply frequency range	2...10 kHz		
Temperature range	-40...+120 °C (H-option 150 °C, H200-option up to 200 °C)		
Operating pressure	150 bar (on the flange side)		
Mounting	M14 x 1 thread or ø 12 mm clamping diameter		
Housing	stainless steel		
Connection	4 core cable output or connector		
cable TPE (standard)	ø 4.5 mm, 0.14 mm ² , non-halogen, suitable for drag chains		
PTFE (option H)	ø 4.8 mm, 0.24 mm ² , max. temperature 200 °C, UL-Style 2895		
max. cable length	100 m between sensor and electronics		

Spring loaded version (up to range 5 mm)			
Spring force (middle of range) [N]	1,20	1,20	1,20
Max. cycles of tip at 1 mm amplitude [Hz]	55	50	50
Spring stiffness [N/ mm][N/ mm]	0,29	0,20	0,12
Life cycle	> 10 million cycles		

Free core/ push rod/ push rod guided	
Max. acceleration of core/ push rod	100 G
Life cycle	infinite

Electronics	IMCA external electronics (built-in)	KAB cable electronics
Output signal	0...20 mA, 4...20 mA (load <300 Ohm) 0...5 V, ± 5 V (load >5 kOhm) 0...10 V, ±10 V (load >10 kOhm)	4...20 mA (load <300 Ohm) 0...5 V, ± 5 V (load >5 kOhm) 0...10 V, ± 10 V (load >10 kOhm)
Temperature coefficient	-0,0055, ±0,002 %/K	
Resolution*	0,04 % of FS	
Corner frequency	300 Hz/-3 dB (6-pole Bessel)	
Isolation stability	> 1000 VDC	
Power supply	9...36 VDC	
Current consumption	75 mA at 24 VDC 150 mA at 12 VDC	65 mA at 24 VDC 140 mA at 12 VDC
Sensor supply	3 V _{eff} , 3 kHz (adjustable, 1-18 kHz)	
Working temperature	-40...+85 °C	
Storage temperature	-40...+85 °C	
Housing	polyamide PA6.6, meets UL94-V0	ABS
Mounting	on DIN EN-rail	bore diameter ø 5,5

* 98.5% confidence interval (confidence limit)

TECHNICAL DIMENSIONS

range (FS) [mm]	max. length A spring loaded mechanics [mm]	core length B [mm]	push rod length C [mm]
0...2	16	22	48
0...5	19	25	54
0...10	-	30	64

type: free core, push rod

free core (B): scope of supply: core (non-magnetic extensions have to be manufactured by customer)

push rod (un)guided (C): scope of supply: core + extension (=push rod)

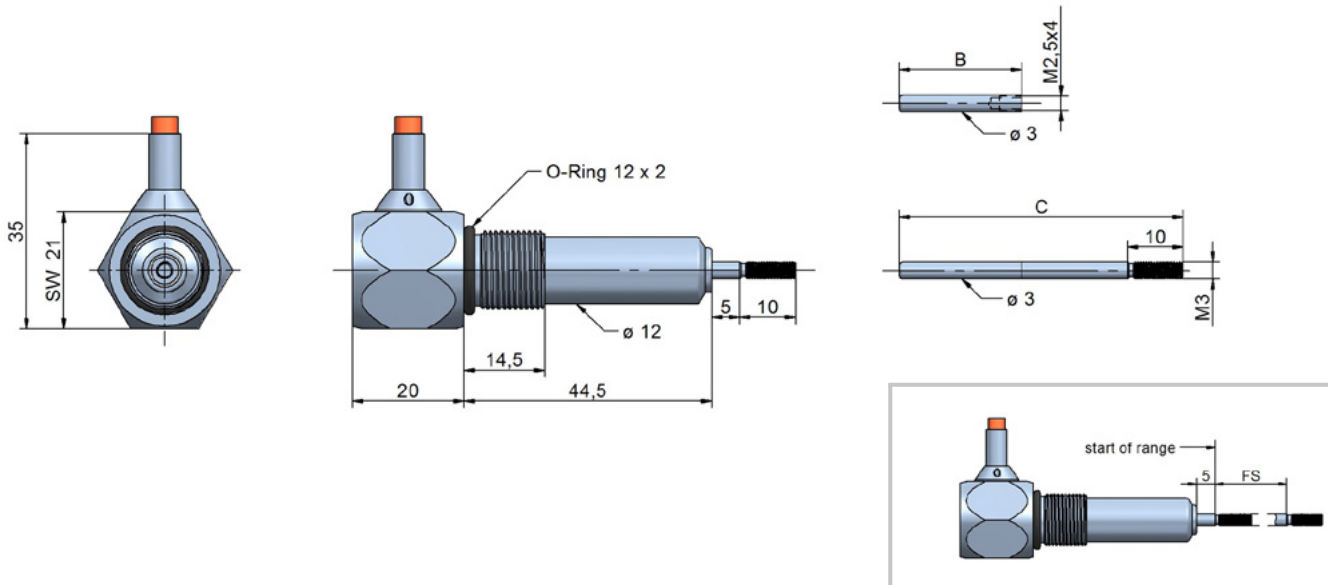

type: spring loaded (up to range 0...5 mm)

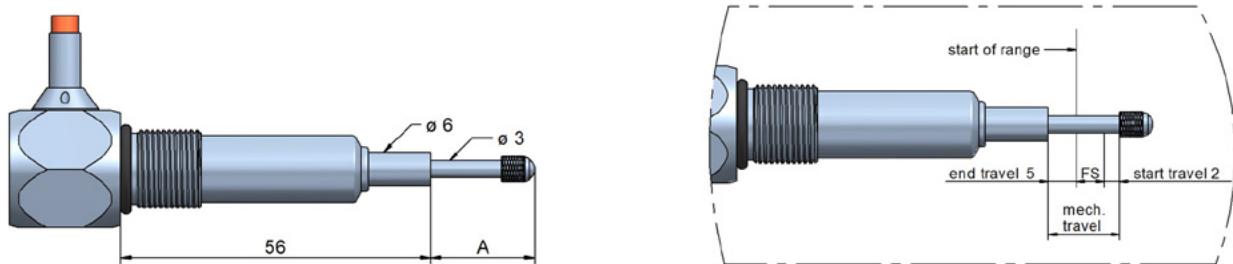

Please note that the stated end travel and start travel (see detailed picture) are standard values. When calibrating the sensors we are aiming for best linearity.

SENSOR TYPES

Output types

Following types for cable and connector outputs are available:

- cable output axial: cable fitting and a spring for bend protection
- cable output radial: cable fitting for strain relief (page 3)
- cable output axial: M12, 4-pole
- cable output radial: LEMO plug, 4-pole

For installation, the bending radius should not be less than 3 times the cable diameter. The standard cable length is 2 m.

Instruments with option H for temperatures up to 150 °C/ 200 °C feature a PTFE cable.

For sensors with connector output the cable has to be ordered separately. You can choose from a cable with a straight connector or with an angular connector. The connector is protected from accidental removal by a threaded fitting (M12). The cable lengths are 2/ 5/ 10 m. The connector pair has a protection class of IP67.

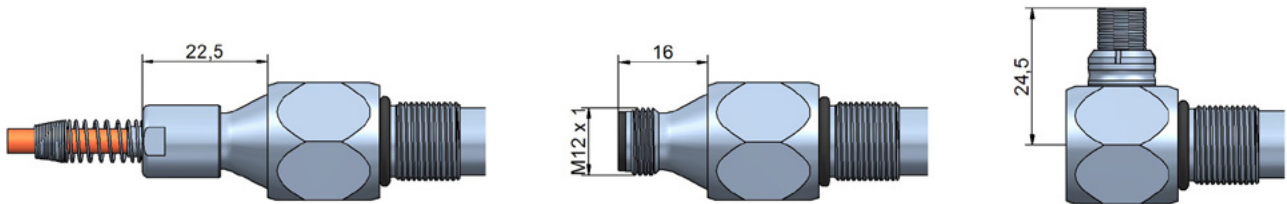

Option VH

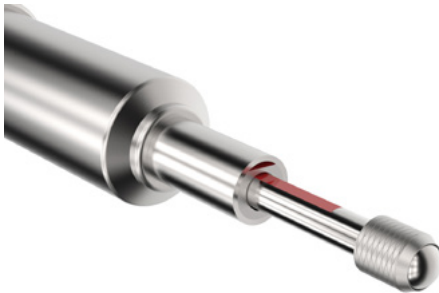

The option VH should be chosen, if the sensor is used in liquids (oil, water, ...) or if fast pressure variations may occur. By milling plane surfaces on parts of the mechanics (see picture red marked) the pressure balance or venting of the inside area will be improved.

For „spring loaded version“: Two plane surfaces combined with a higher spring force of approximately 2,5 N improve significantly the mechanical performance.

For version „guided push rod“: The push rod features a plane surface.

AC-OUTOUT

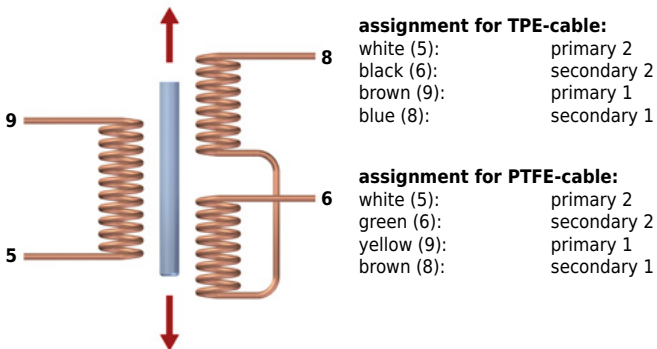

pin assignment M12-connector and LEMO plug

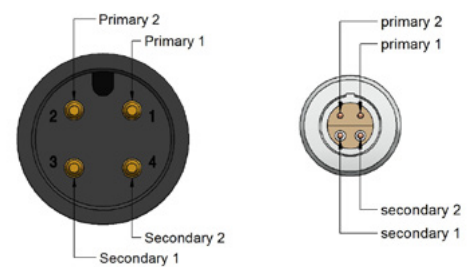

At harsh EMC environments, it is possible to install the electronics at a max. distance of 100 m in a switch cabinet. A twin twisted pair cable (4-cores, minimum cross section 0,5 mm²), single or double shielded, is to be used for the further wiring to connect the external electronics to the system. It is recommended to ground the shield in the switch cabinet near the electronics (do not ground at the machine/ sensor). The sensor housing is grounded at the machine frame. To prevent interference, the cable length should not exceed 100 m.

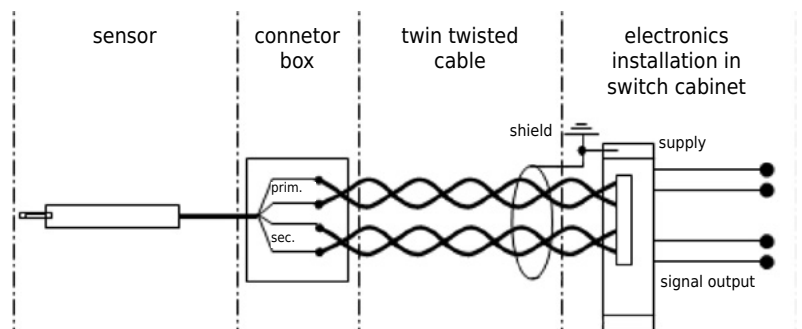

CABLE ELECTRONICS KAB

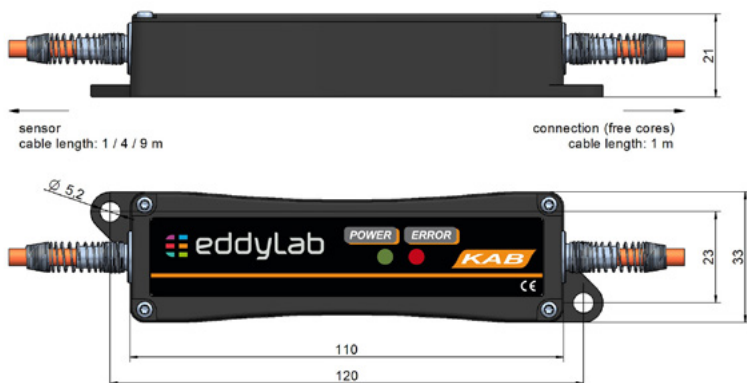

function	cable TPE	cable PTFE-UL
V+	brown	yellow
GND	blue	brown
signal	white	white
signal GND	black	green

If not specified otherwise the cable electronics is placed at 1 m from the end of the cable.

EXTERNAL ELECTRONICS IMCA



external electronics IMCA (for DIN-rail mounting)

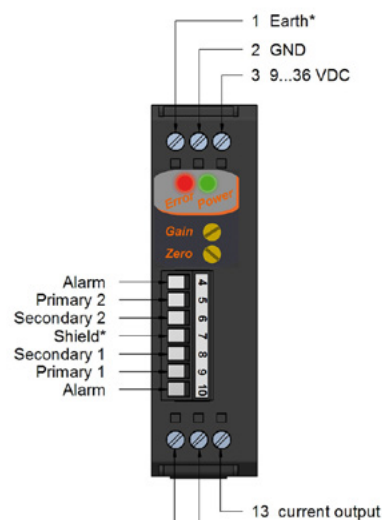
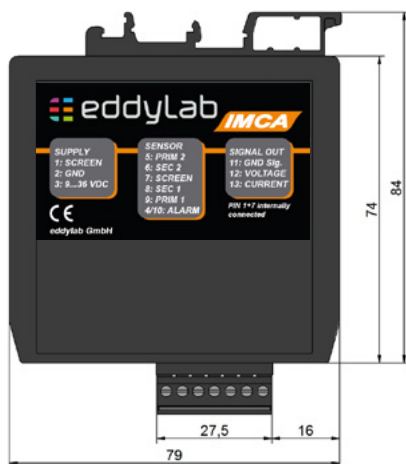

Connection

The external electronics IMCA is designed to be installed in switch cabinets (Din-rail mounting). The connection to the sensor is conducted as connector with push-in spring connection.

ADJUSTMENT OF ZERO POINT AND GAIN

Please note that the zero point and gain may shift for long cable length between sensor and electronics. Thus install the sensor with the according cable length to the electronics and then adjust zero point and gain.

1. Push rod entirely in - adjust offset.
Move the sensor to the zero point of the measuring range and set the offset potentiometer on 4 mA/0 V for the output signal.
2. Push rod entirely out - adjust gain
Move the sensor to the end of the measuring range (push rod moved out) and set the gain potentiometer on 20 mA/10 V/5 V for the output signal.

The output signal is referring to the electric measuring range. If the sensor is operated outside the measuring range or the measuring range is exceeded, the signal is also outside the defined range (i.e. > 10 V/ 20 mA or < 0 V/ 4 mA, in the graph: > 100 % or < 0 %). Please keep this in mind for control systems with cable break detection lower than 4 mA or for a maximum input voltage > 10 V of measuring instruments. If necessary install the sensor **before** connecting to the PLC.

Running direction of signal: If the push rod is moving into the sensor (e.g. sprung load pushed in), the signal is reducing. If the push rod is moving out, the output signal is increasing. The running direction of the signal can also be inverted.

Signal inversion:

If an inverted output signal is required (20...4 mA /10...0 V/5...0 V), swap clamps 6 and 8 (secondary coil) on the external electronics.

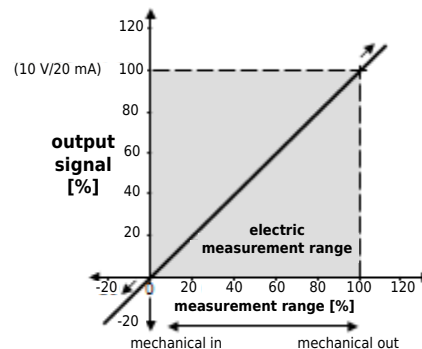

CABLE BREAK DETECTION

The electronics by eddylab feature a built-in cable break detection. This is achieved by an impedance measurement of the LVDT's secondary coil. If the sensor cable is cut, the impedance on the secondary connections of the electronics change regardless of the push rod position, triggering the cable break detection. This feature is based on a broken secondary connection. A partial cable break of the primary connections (cables between primary coil and electronics) will not activate this function. The electronics vary in their functional range. The external electronics IMCA offers the widest range. The cable electronics KAB only visualises a cable break by a red LED.

IMCA: For the use of the cable break functions an alarm system (signal lamp, acoustic alarm device) or an alarm input of the PLC must be connected to the 7-pole terminal. The circuit board features a analog switch which is a normally open.

Normal operation IMCA:

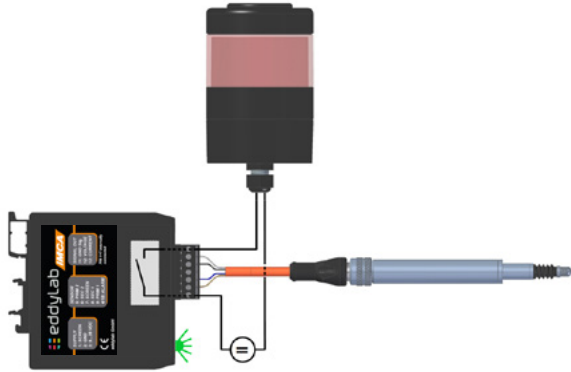

- The green „POWER-LED“ on the front side is on.
- The signal output is active.
- The alarm output is disabled.

Cable break IMCA:

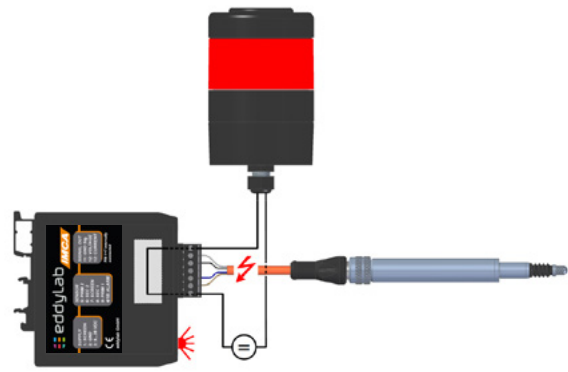

- In case of a cable break the analog switch closes and the alarm system is activated or an electrical signal is conducted. Please note the maximum electrical values: 30 mA or 14 V.
- A front side „ERROR-LED“ flashes in case of an error.
- The signal output is deactivated. There is no current or voltage signal.

ACCESSORIES

Connection cable (shielded) for connector output

Cable M12 with straight connector

K4P2M-S-M12	2 m
K4P5M-S-M12	5 m
K4P10M-S-M12	10 m

Cable M12 with angular connector

K4P2M-SW-M12	2 m
K4P5M-SW-M12	5 m
K4P10M-SW-M12	10 m



Mating connector M12 for self assembly (shielded)

	straight connector D4-G-M12-S	angular connector D4-W-M12-S	straight connector Lemo FGG.05
Protection class	IP67		IP50
Temperature range	-25...+90 °C		-40...150 °C
Connection	spring-cage construction		solder connection
Cable diameter	ø 4...8 mm		ø 3,7...4,5 mm
Conductor	0,14...0,34 mm ²		0,14...0,25 mm ²



Feeler for spring loaded version

Tastkopf-01, steel (standard) Tastkopf-01-HM, carbide Tastkopf-01-R, ruby Tastkopf-01-K, ceramics		Tastkopf-02, steel Tastkopf-02-HM, carbide		Tastkopf-03, steel Tastkopf-03-HM, carbide	
Tastkopf-04, steel		Tastkopf-05, steel		Tastkopf-782.238, roller	

ORDER CODE SENSOR

SM **X** - **X** - **X** - F14 - **X** **X** **X** **X** **X** **X**
a **b** **c** **d** **e** **f** **g** **h** **i**

a measurement ranges [mm]

2 / 5 / 10

b type

A = free core
 S = unguided push rod
 SG = guided push rod
 T = spring loaded

c cable/ connector

KA = axial cable output
 KR = radial cable output
 SA = axial connector output M12
 SR = radial connector output LEMO

d cable / connector output

S1: sensor with connector output

1 = connector output

S2: sensor with cable output, open cable end (for IMCA)

A = TPE cable 2 m
 B = TPE cable 5 m
 C = TPE cable 10 m
 D = PTFE-UL cable 2 m (option H)
 E = PTFE-UL cable 5 m (option H)
 F = PTFE-UL cable 10 m (option H)

S3: sensor with cable output for KAB

G = TPE cable 2 m
 H = TPE cable 5 m
 J = TPE cable 10 m
 K = PTFE-UL cable 2 m (option H)
 L = PTFE-UL cable 5 m (option H)
 M = PTFE-UL cable 10 m (option H)

e linearity

1 = 0,30 % (standard)
 2 = 0,20 % (option L20)
 3 = 0,10 % (option L10)

f temperature range

1 = -40...+120 °C (standard)
 2 = -40...+150 °C (option H)
 3 = -40...+200 °C (option H200)

g push rod sealing

1 = standard
 2 = ventilation hole (option VH)

h protection class

1 = IP67
 2 = IP68 (option IP68)

i spring force

1 = for type „A/S/SG“
 2 = standard
 3 = HD2.5 (approx. 250g)
 4 = HD (approx. 500g)

ORDER CODE ELECTRONICS

IMCA - 24V - **X**
a

KAB - 24V - **X** - **X**
a **b**

type

IMCA = external electronics
 KAB = cable electronics

a output signal

020A = 0...20 mA
 420A = 4...20 mA
 10V = 0...10 V
 5V = 0...5 V
 ±5V = -5...5 V
 ±10V = -10...10 V

b KAB: type of cable / cable length

E1: for sensor with cable output

- = KAB integrated in sensor cable

E2: for sensor connector output

A = cable 2 m, M12 straight female connector
 B = cable 2 m, M12 angular female connector
 C = cable 5 m, M12 straight female connector
 D = cable 5 m, M12 angular female connector
 E = cable 10 m, M12 straight female connector
 F = cable 10 m, M12 angular female connector

possible combinations:

- S1: sensor with connector output
- S2: sensor with cable output
- S3+E1: sensor with cable output, KAB integrated in sensor cable

- S1+E2: sensor with connector output, cable electronics with cable K4PxM
- S1+E3: sensor with cable output, cable K4PxM, external electronics IMCA
- S2+E3: sensor with cable output, external electronics IMCA

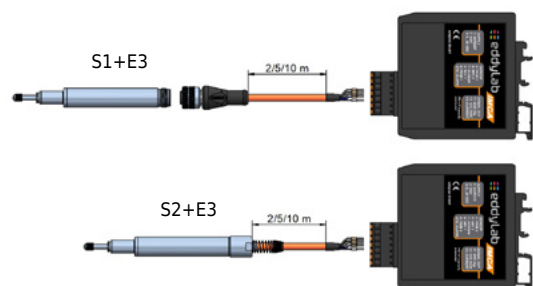
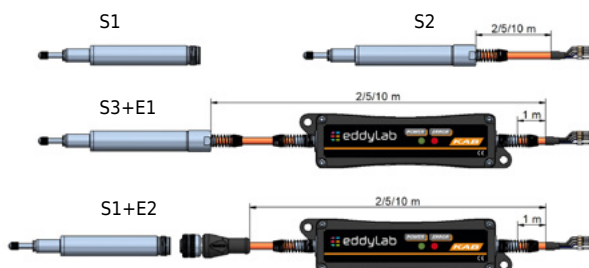



Subject to change without prior notice.

eddylab GmbH
Mehlbeerenstr. 4
82024 Taufkirchen

Tel. +49 (0)89 666 16 11-0
Fax +49 (0)89 666 16 11-100

E-mail info@eddylab.de
Internet www.eddylab.de

